

EE/EET 2240
Homework Problem #04

For the circuit shown below:

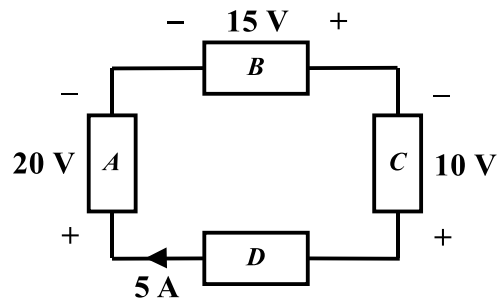

- Does component *A* *absorb* power or *deliver* power? How do you know?
- Does component *B* *absorb* power or *deliver* power? How do you know?
- Does component *C* *absorb* power or *deliver* power? How do you know?
- Does component *D* *absorb* power or *deliver* power? How do you know?
- Show that power is conserved.